

# 1080P Full HD WiFi Digital Microscope

(for iOS/Android, PC)

User's  
Manual

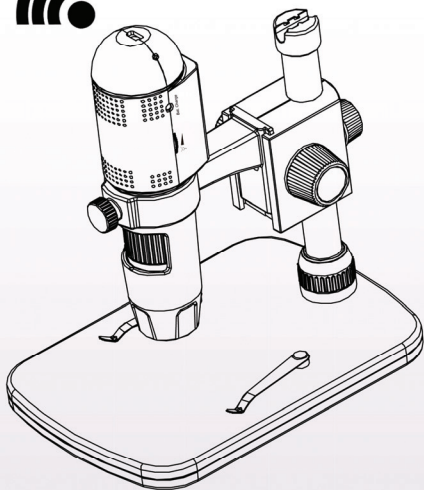

# Table of Contents

Precaution.....	2
Preparation.....	3
● Standard accessories.....	4
● Parts Names & Functions.....	5
● System requirements.....	6
● Technical Specifications.....	6
Use on iOS/Android Device by WiFi.....	7
● Insert a Micro-SD card.....	7
● Download App.....	7
● Connect to iOS/Android Device.....	8
● Start preview.....	10
● Take a photo.....	11
● Record video.....	11
● Playback.....	12
● Download files to Smart phone.....	13
● Delete files.....	14
● Settings.....	15
Install the microscope to Stand.....	16
How to get focus.....	19
Use the microscope on PC.....	20
Install Software on PC.....	21
Start Microscope.....	22
Software functions.....	23
● Capture Photo.....	23
● Capture Video.....	23

● Timer.....	24
Calibration and Measurement.....	25
● Calibration.....	26
● Measurement.....	29
● Change Calibration.....	30
● Draw and text.....	33
Software Interface Instructions.....	34
● Main Interface Icons.....	34
● Main Menu.....	35
● Options.....	36
● Capture.....	37
● Measurement Interface Instruction.....	38
Troubleshooting.....	39

## **Welcome**

Thank you for your choice of our product - it is a high-tech while easy to use 1080P Full HD WiFi Digital Microscope. With this unit you will see a unique and “bigger” world via iOS/Android devices.

It’s easy to zoom in on stamps, coins, paper currency, plants, insects, skin, fabrics, rocks and minerals, and so much more.

We recommend reading this manual first to get the best out of this unit.

# 1. Precaution

Before using the WiFi Digital Microscope, please ensure that you read and understand the safety precautions described below. Always ensure that the WiFi Digital Microscope is operated correctly.

- The Microscope is not waterproof, so keep it dry.
- Do not use it in a humid place like bathrooms. A dry environment will maintain its life to maximum.
- Use the Microscope only at  $-5^{\circ}\text{C}$ - $50^{\circ}\text{C}$ .
- Sudden temperature change may form dew inside the Microscope like entering a warm room in cold winter. Put it inside a handbag or plastic bag to slow down temperature changes.
- Do not point Microscope lens to the sun or strong light for a long time. Powerful light may hurt the light-sensitive electronics.
- Avoid touching the lens.
- The white LEDs which illuminate the Microscope target field are very bright. Do not stare directly into these LEDs as it may damage your eyes.
- The clear plastic distance shell sometimes picks up dirt or toxic material from a microscopically observed surface. Be careful that this doesn't get in contact with the human skin. Always wash carefully or disinfect as needed.

## 2. Preparation

### ■ Standard accessories



WiFi Microscope

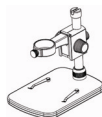

Stand

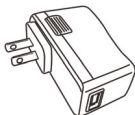

AC adaptor



USB cable



User manual

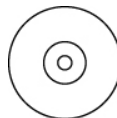

AC adaptor



Calibration Ruler



Cleaning Fabric

## ■ Parts Names & Functions

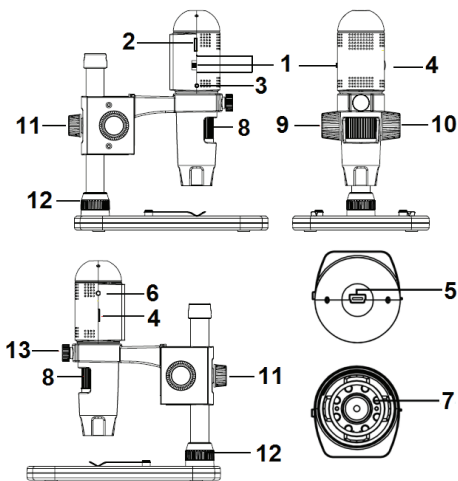

Part#	Meaning	Part#	Meaning
1	OFF/WiFi/USB	8	Focus wheel
2	Micro-SD slot	9	Wheel (Fixing the movement)
3	Reset	10	Wheel (for up/down)
4	LED Dimmer	11	Wheel (fixing on the pole)
5	USB (PC and Charge)	12	Wheel (fixing on the stage)
6	Charging indicator	13	Wheel (fixing the microscope)
7	LED		

## ■ System Requirements

### 1. iOS/Android

- \* iOS 5.1 and later
- \* Android 4.3 and later

### 2. PC

- \* Windows XP / VISTA / WIN7 / WIN8 / WIN10
- \* P4 1.8 or above
- \* RAM: 512M
- \* Video Memory: 64M
- \* USB port: 2.0
- \* CD-ROM Drive

## ■ Technical Specifications

Image sensor	3 Mega Pixels (true resolution)
Still capture resolution	3M, 5M, 8M, 12M
Video capture resolution	1920x1080 (1080P), 1280x720 (720P), 640x480 (VGA)
Magnification Ratio	10x~220x
Focus Range	Manual focus from 0mm to 50mm
Video format	H.264
Photo format	JPEG
Light source	6 LED (adjustable by control wheel)
Power source	Rechargeable Li-ion battery Working time: 3hrs, Charging time: 2hrs Charging power: 5V DC
iOS/Android interface	WiFi

App	iOS (5.1 and later): WiFiCapture Search and download from App Store Android: MicroCapture, Install from CD, or search and Download from <a href="https://play.google.com/store">https://play.google.com/store</a>
PC interface	USB2.0
PC Software	PortableCaptureHD (with measurement)
PC Software Language	English, Deutsch, Spanish, Russian, Italian, French, Portuguese, Dutch, Polish, Japanese, Korean
PC Software OS Supported	Windows XP/Vista/Win7/ Win8/Win10
Size	Microscope: 154mm (L) x 44mm (R) Professional Stand: 165mm(L) x118mm(W)x12mm (H)

### 3. Use the WiFi Microscope on iOS/Android Device

#### 1) Insert a Micro-SD card

Insert a Micro-SD card (not included) to the card slot!

Please note that the Micro-SD card does not supply hot plug in/out, so please always insert or take out the SD card when the microscope is OFF. If you insert or take out the SD card when the microscope is on, sometimes the microscope will get halted. In such a case, please use a pin to press the Reset button. For detailed operation, please refer to troubleshooting.



## 2) Download App

### iOS:

Search and install MicroCapture from App Store.

### Android:

Search MicroCapture from [play.google.com/store](http://play.google.com/store), download and install it. Or install MicroCapture from the CD that comes with the package.

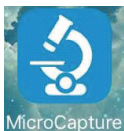

## 3) Connect the WiFi Microscope to iOS/Android device. (here we take iOS device as an example)

- (1) Power on the microscope by sliding the Part#1 to WiFi position;
- (2) Turn on the WiFi of your iOS/Android Device, search the WiFi Digital Microscope from the WiFi Device list. The WiFi Microscope name is WiFi Microscope\_xxx (xxx is a random number), as follows:

The password to connect the device is **12345678**.

Please refer to **Settings** on how to change the password.

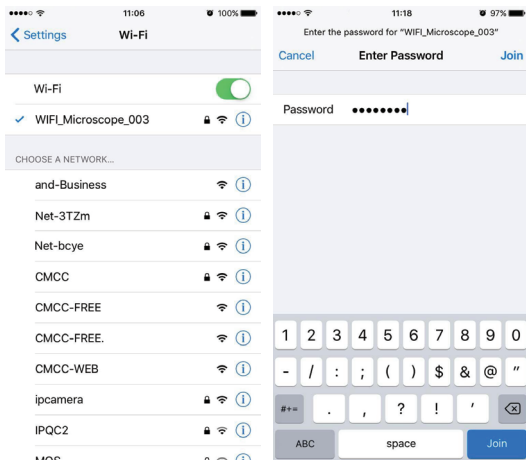

#### 4) Start preview

Start the installed App, live video will show as follows:

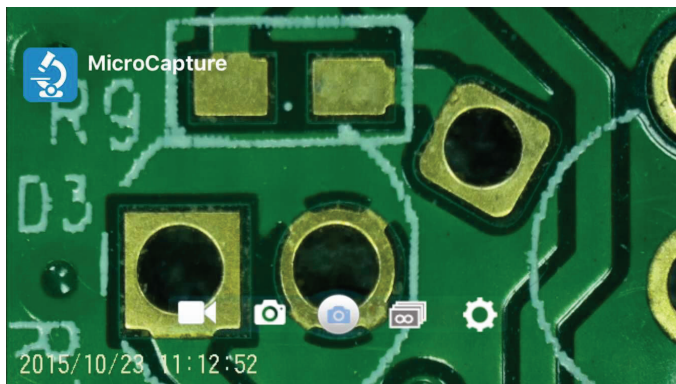
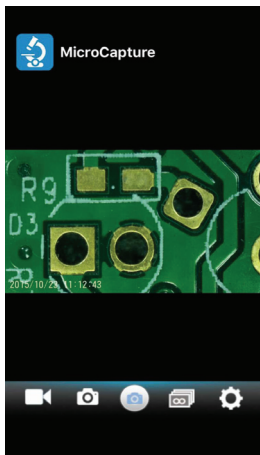



## 5) Take a photo



Click  and then a photo will be taken!

## 6) Record video



Click  and then the central icon will be , then click the red dot, video recording will start, click again to stop the recording.

## 7) Playback

By default, the captured files are stored in the Micro-SD card in the microscope. You can preview them and download them to your Smart phone.



Click  to enter playback as follows.

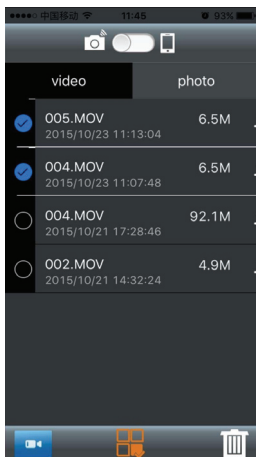

## 8) Download files to Smart phone



By clicking , you can download file to your Smart phone. You can choose if to download the original file or downsized (fast download).



By sliding the dot to the cell phone icon, you can see files that are already downloaded and stored in your phone.

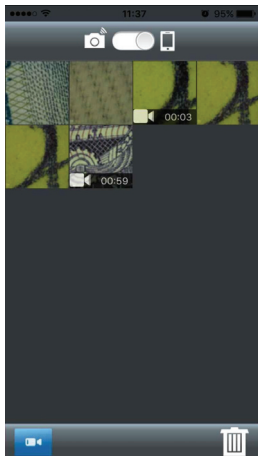

## 9) Delete files



Click from the bottom bar, tick the files to be



deleted, and then click. Finally confirm the delete.

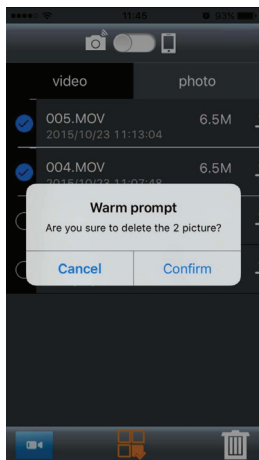

## 10) Settings



Click , you can enter into setup screen as follows.

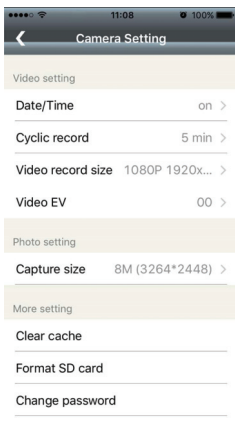

**Date/Time:** turn on/off the date stamp

**Cyclic record:** turn on/off the cyclic recording.

**Video record size:** change the video size among 1080P, 720P and VGA

**Video EV:** adjust the EV

**Capture size:** change the photo size among 3M/5M/8M/12M.

**Clear cache:** helps to clear history redundancy and keep video frequent.

**Format SD:** format Micro-SD card

**Change password:** helps to change WiFi connection password (12345678 by default).

Please see troubleshooting on how to do if you forget your new password.



## 4. Install the Microscope to the Stand

- 1) Take the microscope out from gift box gently; put the carriage stage on a flat surface.
- 2) Follow the below steps:

### Step 1

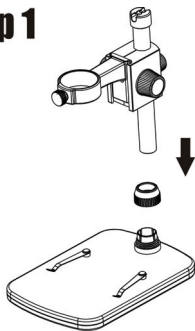

Put the metal pole through Wheel 12!

### Step 2

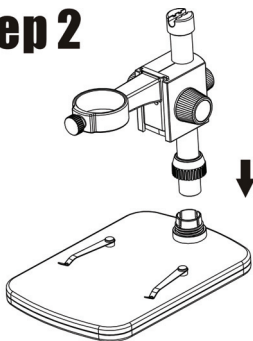

Put the metal pole into the female part of the stage!

## Step 3



Rotate Wheel 12  
to fix the pole  
on the stage!

## Step 4

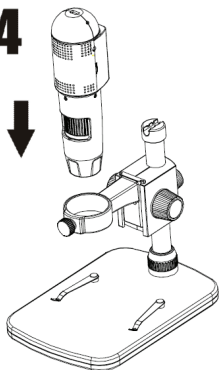

Put the  
microscope into  
the ring of the  
stand!

# Step 5

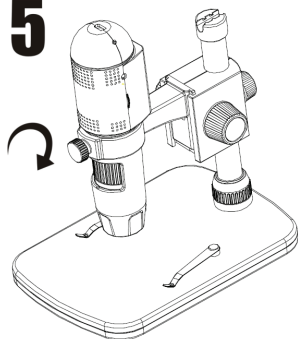

Rotate Wheel 13 clockwise to fix the microscope on the ring.

(1) Adjust the upper part of the stand to get a proper height.

(2) Rotate Wheel 9 clockwise to fix the upper part.

# Step 6

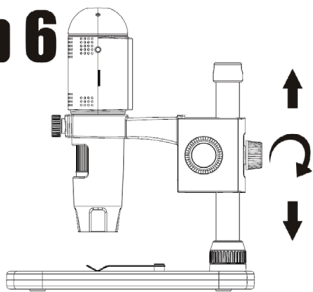

## 5. How to get focus

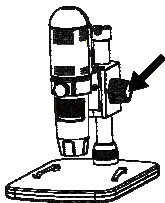

**Rotate Wheel 10 to get a rough focus!**

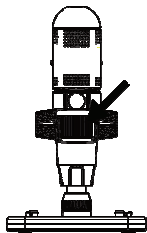

**Rotate Wheel 8 to get a fine focus!**

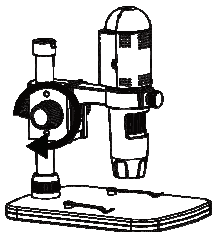

**Rotate Wheel 9 to lock or release the movement!**

## **6. Use the Microscope on PC**

When connecting to PC, there are two statuses.

- 1) With Micro-SD card inserted, it is mass storage. You can visit files stored on the Micro-SD card.
- 2) Without Micro-SD card inserted, it is PC Camera status. You can output live video to computer. Please see Point-7 for how to use the software on PC.

## 7. Install the Software on PC (Windows)

Insert the driver CD into CD-ROM Drive and this will automatically display the following interface:

### ☐☐ Digital Microscope ☐☐

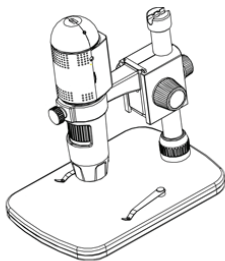

Install PortableCaptureHD

User's manual

Browse the CD

Exit



#### 1) Install MicroCaptureHD

Click Install **MicroCaptureHD** and the installation wizard will guide you through the whole process.

#### 2) Full user's manual can be viewed by clicking **User's Manual**.

## 8. Start Microscope

Take out Micro-SD card, connect your Microscope to your

PC USB port, start the software by clicking the  icon generated on the desktop after installation and you will see the following screen pop up.

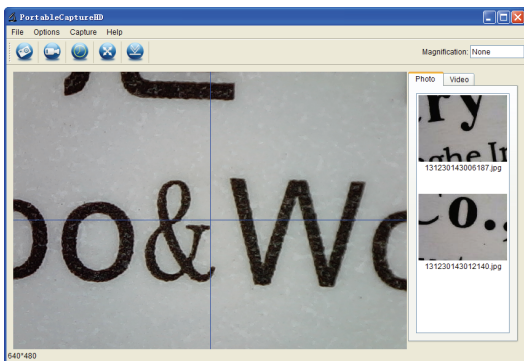

When the Microscope is disconnected from your PC USB port, the following message will pop up.

**No Device detected, please  
connect your Microscope  
directly to your PC USB port.**

## 9. Software Functions

### ■ Capture Photo

a. Click 'Photo' shortcut icon  in the main menu bar.

b. Click 'Capture > Photo'.

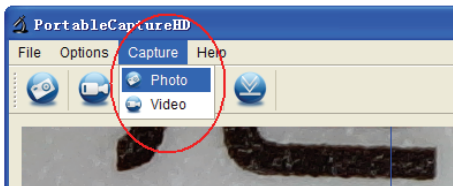

### ■ Capture Video

a. Click 'Video' shortcut icon  in the main menu bar.

b. Click 'Capture > Video'.

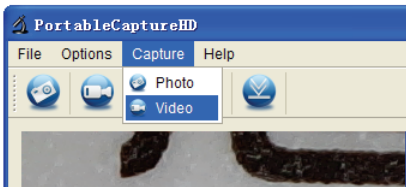



## ■ Timer (Photo / Video)



Click 'Timer' shortcut icon in the main menu bar.

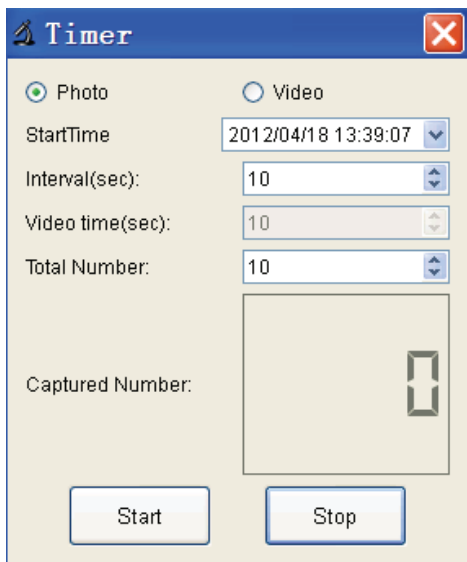

\* Under Timer photo, you can set the start time, interval time and total picture number.

\* Under Timer video, you can set the start time, interval time and total video number.

## ■ Calibration and Measurement

Please make calibration before measurement.

### Calibration

Display Crossing from 'Options>Crossing'.

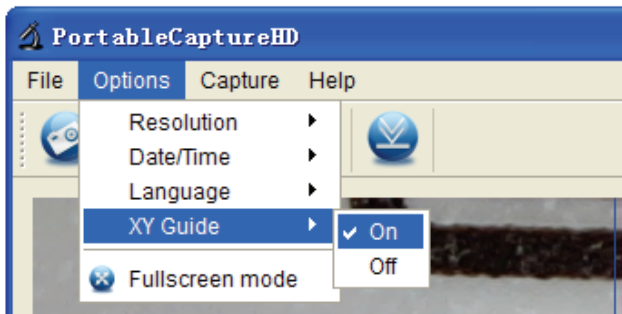

Microscope default at crossing “on”

It's used to check the dial on the calibration ruler.

1. Focus microscope on the attached calibration ruler



and then adjust the magnification till the picture is clear. Take a picture for the selected area when the dial is parallel to the crossing as below.

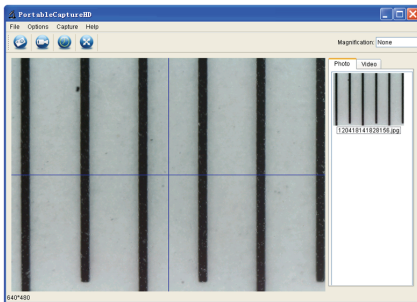

2. Double-click on the picture to enter into measurement interface as below.

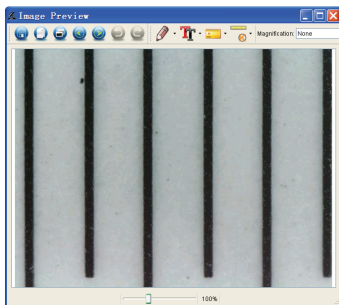

3. Click Calibration icon , and then move mouse to the picture. Click on the beginning and ending points across a known value. Now a dialog will popup as below and you need to enter the exact value of the measurement sample into 'Actual dimension'. Then the software will automatically calibrate the magnification rate. Click 'OK' and the adjusted magnification rate will show in the upper right corner.

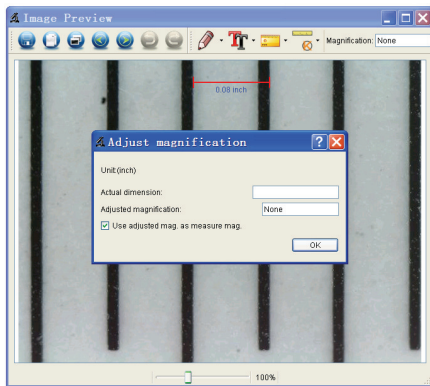

\* Remark: The measured line should be paralleled.

4. Now you can use 'Any angle Line' under Measurement

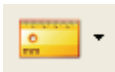

icon to measure the value again. If the value you measure by software is nearly the same as the exact value of the dial means the calibration finish.

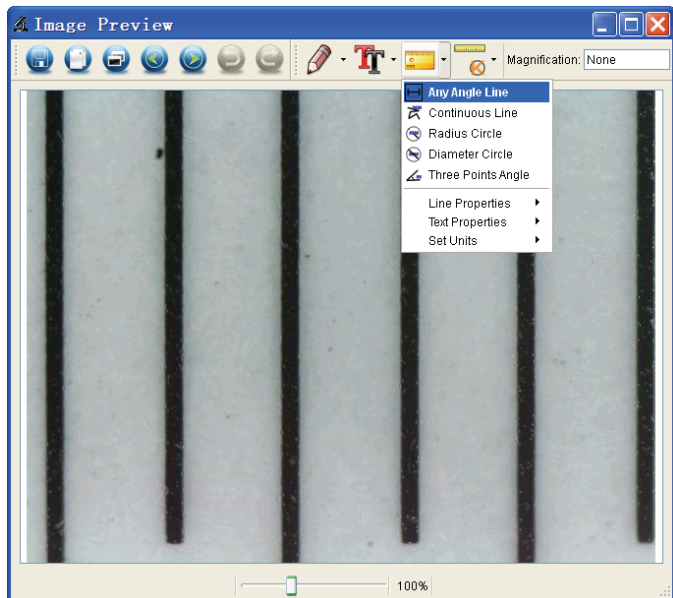

## Measurement

Double-click on the picture to enter into measurement interface. Under the 'Measurement' icon  , you can choose any desired options to measure.

### 1. Any Angle Line Measurement

Simply click from one point and drag to the next point, and then release the click.

### 2. Continuous Line Measurement

The Continuous Line measurement allows you to measure any continuous desired length.

Simply click and drag from one point to other desired points, and then release the click.

### 3. Radius Circle Measurement

Simply click and extend out to the desired radius, the radius, circumference and area of the circle will show up accordingly.

### 4. Diameter Circle Measurement

Simply click and extend out to the desired diameter, the diameter, circumference and area of the circle will show up accordingly.

### 5. Three Points Angle Measurement

Simply define any three points angle and click, the angle value will then display.

## Change Calibration

If you need to change the magnification rate and adjust focus to capture picture, please calibrate the magnification rate again.

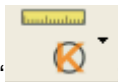

1. Double click to open the picture, Click 'Reset magnification > Reset picture magnification' as below. And then start calibration again (Calibration details please refer to page37).

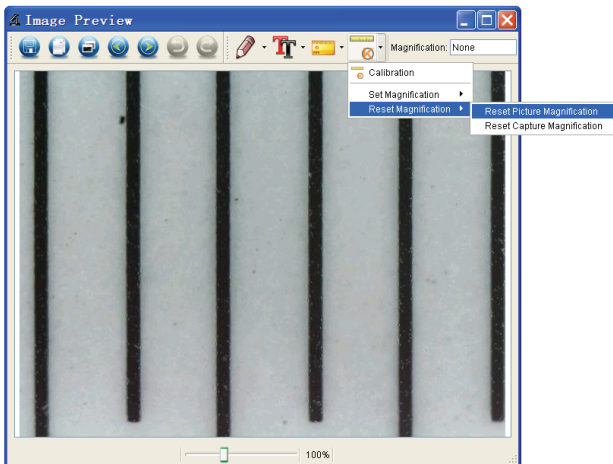

2. Change the magnification rate and capture several pictures, click on the picture to enter into measurement



interface. And click 'Set magnification > Set picture magnification', now a dialog will show up as below; enter the magnification rate into the dialog and click 'OK'.

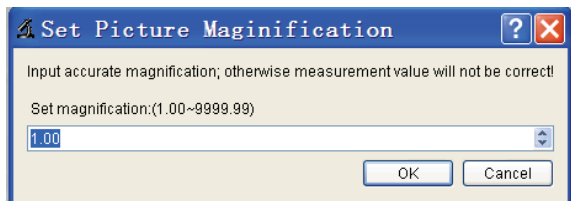
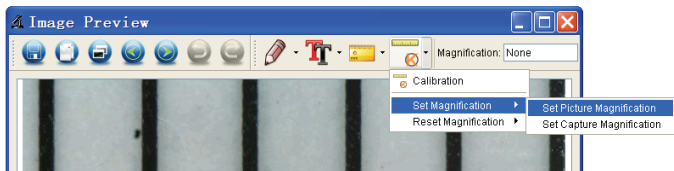



3. If you want to use the same magnification rate to



capture pictures, just click ' > Set magnification > Set capture magnification'. Now all pictures will use the same magnification rate and you can start measurement directly.

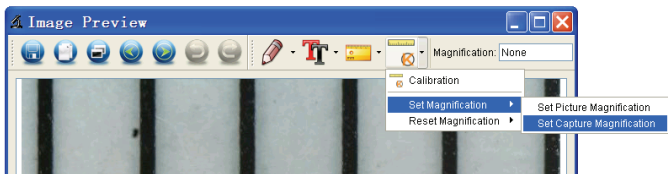

## Draw and Text

You can draw or add a text on the picture and save for later analysis.



1. Click icon to choose any kinds of drawing under the pull-down manual as below.

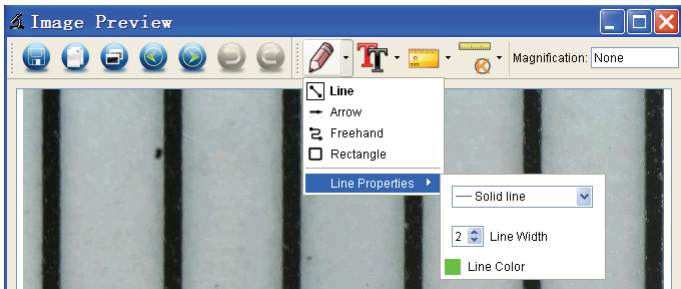

2. Click icon and set the font for the text in the popup dialogue as below.

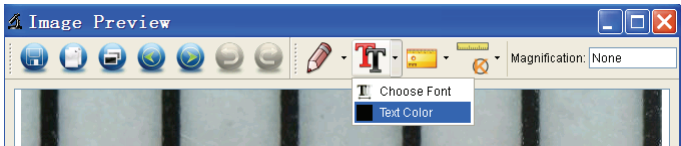

## 10. Software Interface Instructions

### Main Interface Icons



Capture photo – It's used to capture photo one by one.



Start / Stop record video.



Timer for photo / video – Set the start time, interval time and total photo/video number.



Full screen mode,  
Press ESC or double-click to exit.

## Main Menu

### File

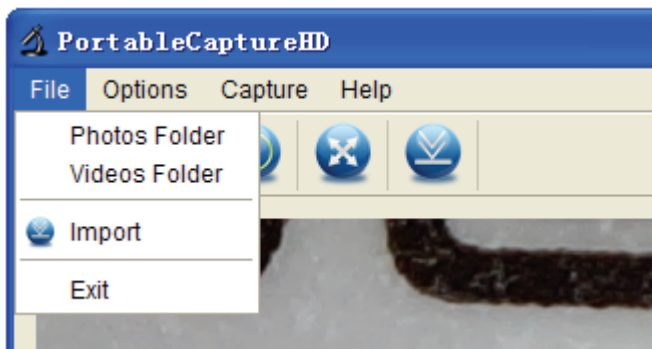

**Photos Directory:** set the directory to store photos taken;

**Videos Directory:** set the directory to store video taken;

## Options

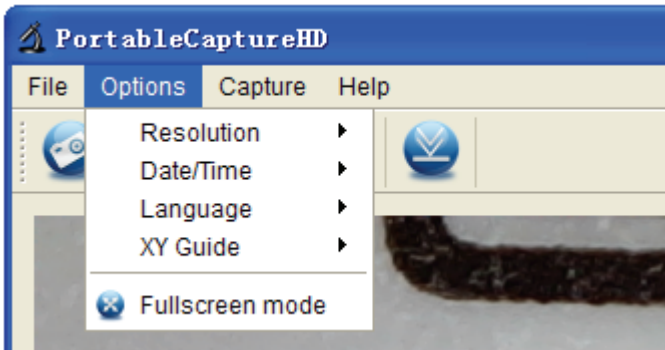

**Resolution:** change preview size

**Date/Time:** set to display system date/time on preview window

**Language:** choose different OSD language

**Crossing:** display cross on preview window

**Full-screen mode:** enter into full screen. Click ESC or double click to exit

## Capture

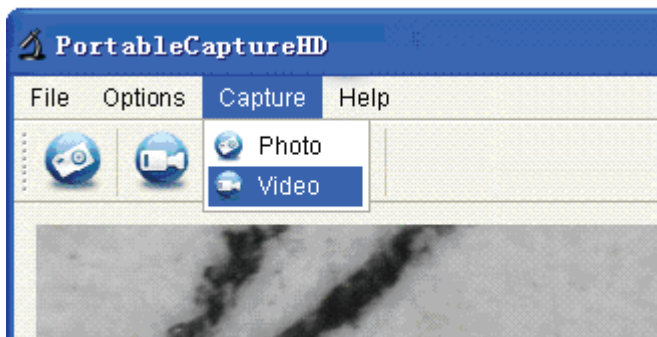

Photo: take a photo

Video: record a video clip

## Measurement Interface Instructions



Save as



Redo



Copy to  
clipboard



Draw



Copy file



Text note



Previous



Measurement



Next



Calibration



Undo

## 11. Troubleshooting

Problem	Solution
After switched to WIFI position, the LED does not light.	1). Rotate the LED dimmer to check if it is on. 2). Charge the battery.
The microscope is halted.	When the microscope is on, use a pin to press the Reset button, and then power it on again.
The preview by WiFi is quite slow.	Reset the microscope by using a pin to press the Reset button when the microscope is on and then power it again.  Go to app, enter Setting and carry out Clear cache.
I forget my new WIFI connection password.	Create a .txt file named PASSWORDRESET, type YES in the file, and then put the file in a Micro-SD card. Please make sure that it is the only file in the card. Insert the card to microscope and power it on by sliding to WIFI



	position. And then the password will be restored to 12345678.
--	---

This symbol on the product or in the instructions means that your electrical and electronic equipment should be disposed at the end of its life separately from your household waste. There are separate collection systems for recycling in the EU. For more information, please contact the local authority or your retailer where you purchased the product.

