



# NF200

BENCH TOP CENTRIFUGE

USER'S MANUAL

## MANUFACTURER

### NÜVE SANAYİ MALZEMELERİ İMALAT VE TİCARET A.Ş.

Saracalar Mah. Saracalar Kümeevleri No: 4/2

Akyurt 06750 Ankara

**TEL:** +(90) 312 399 28 30 (pbx)

**FAX:** +(90) 312 399 21 97

**E-mail:**satis@nuve.com.tr

## WARRANTY CERTIFICATE

1. Nüve warrants that the equipment delivered is free from defects during material and workmanship. This warranty is provided for a period of two years. The warranty period begins from the delivery date.
  2. Warranty does not apply to parts normally consumed during operation or general maintenance or any adjustments described in the operating instructions provided with the equipment.
  3. Nüve does not accept any liability in the case where the goods are not used in accordance with their proper intent.
  4. The warranty may not be claimed for damages occurred during the shipment, for damages resulting from improper handling or use, the defects in maintenance, negligence, bad functioning of auxiliary equipment, in the case of force majeure or accident and incorrect power supply.
  5. In the event of failure, Nüve shall be under no liability for any injury, or any loss or damage as the result of the failure other than the guarantee conditions.
- **BEFORE OPERATING THE INSTRUMENT THIS MANUAL SHOULD BE READ CAREFULLY.**
  - **THE VALIDITY OF THE GUARANTEE IS SUBJECT TO THE OBSERVATION OF THE INSTRUCTIONS AND PRECAUTIONS DESCRIBED IN THIS MANUAL.**
  - **INFORMATION CONTAINED IN THIS DOCUMENT IS THE PROPERTY OF NÜVE. IT MAY NOT BE DUPLICATED OR DISTRIBUTED WITHOUT PERMISSION.**

## DEAR NUVE USER

We would like to take this opportunity to thank you for preferring this Nüve product. Please read the operating instructions carefully and keep them handy for future reference.

Please detain the packing material until you see that the unit is in good condition and it is operating properly. If an external or internal damage is observed, contact the transportation company immediately and report the damage. According to ICC regulations, this responsibility belongs to the customer.

While you are operating the instrument please;

- obey all the warning labels,
- do not remove the warning labels,
- do not operate damaged instrument,
- do not operate the instrument with a damaged cable,
- do not move the instrument during operation.

In case of a problem contact your Nüve agent for an authorized service or maintenance.

The validity of the guarantee is subject to compliance with the instructions and precautions described in this manual.

Nüve reserves the right to improve or change the design of its products without any obligation to modify previously manufactured products.

Information contained in this document is the property of Nüve. It may not be duplicated or distributed without its permission.

**PLEASE REGISTER ONLINE TO VALIDATE WARRANTY:**

To register your warranty online, please visit our web page [www.nuve.com.tr](http://www.nuve.com.tr) and fill in **WARRANTY REGISTRATION FORM**.

## TABLE OF CONTENTS

SECTION 1 – INTRODUCTION .....	4
1.1. USE AND FUNCTION .....	4
SECTION 2 – TECHNICAL SPECIFICATIONS .....	5
2.1. TECHNICAL SPECIFICATIONS TABLE .....	5
2.2. ACCESSORIES FOR NF200 .....	5
2.3. GENERAL PRESENTATION .....	6
2.4. RECAUTIONS AND USAGE LIMITATIONS .....	6
SECTION 3 – SYMBOLS .....	7
SECTION 4 – INSTALLATION .....	7
4.1. LIFTING AND TRANSPORT .....	7
4.2. UNPACKING .....	7
4.3. POSITIONING .....	7
4.4. MAIN SUPPLY .....	8
SECTION 5 – OPERATING UNIT .....	8
5.1. OPERATING .....	8
5.2. DISPLAY AND CONTROL PANEL .....	8
5.3. MAKING PROGRAM .....	9
5.3.1 PULSE MODE .....	10
5.4 SAFETY INTERLOCK SYSTEM .....	11
5.5 MANUAL LID OPENING .....	11
SECTION 6 – OPERATING PRINCIPLES .....	12
6.1 PREPARATION OF THE ROTOR TO RUN .....	12
6.2 LOADING .....	12
6.3 DRIVE SYSTEM .....	13
SECTION 7 – CLEANING AND PERIODIC MAINTENANCE .....	13
7.1 PERIODIC MAINTENANCE .....	13
7.2 STERILIZATION .....	13
7.3 CORROSION INFORMATION .....	13
7.4 CLEANING .....	14
7.5 ELECTRICITY .....	14
SECTION 8 – DISPOSAL MANAGEMENT CONCEPT .....	14
BÖLÜM 9 – TROUBLESHOOTING .....	15
SECTION 10 – ELECTRICAL CIRCUIT DIAGRAMS .....	16
SECTION 11 – WARNING LABEL .....	17

## SECTION 1 – INTRODUCTION

### 1.1. USE AND FUNCTION

NF 200 Bench Top Centrifuge is especially designed for the separation of blood samples, sedimentation of urine particles and for the separation of substance or substance mixtures in laboratories.

By means of the programmable microprocessor control system, speed, RCF value and time could be programmed and the 'pulse' function allows the operator to run short spins.

NF 200 ensures safe operation by means of the locking system which does not allow the centrifuge to operate if the lid is open the lid cannot be opened while the rotor is spinning.

There are audible and visible alarms to inform the operator when the lid is open, when the program ends and when any error condition occurs. In case of a power failure, the lid could be opened manually by using a manual lid opening tool. There is also an observation hole on the lid to check the speed of the centrifuge by a tachometer.

NF 200 is delivered with 12x15 ml angle rotor made of polypropylene.

**NF 200 Bench Top Centrifuges are manufactured according to the following standards,**

**EN 61010-1, EN 61010-2-020, EN 61000-6-3, EN 50419, EN 61326-1.**

**This device is in compliance with WEEE Regulation.**

## SECTION 2 – TECHNICAL SPECIFICATIONS

### 2.1. TECHNICAL SPECIFICATIONS TABLE

Technical Specifications	NF 200
Maximum speed	5.000 rpm
Maximum RCF	2.822xg
Tube capacity	12 x 15 ml
Control system	Programmable Microprocessor Control System
Speed set range	1.000-5.000 rpm
Speed set step	10 rpm
Timer set range	1-99 min. and hold position
Timer set step	1 minute
Motor	Induction Motor
Power Supply	230 V, 50/60 Hz
Power Consumption	150 W
External Dimensions (WxDxH) mm.	280x360x260
Packet Dimensions (WxDxH) mm.	350x420x460
Net / Packed weight (kg)	12/16

### 2.2. ACCESSORIES FOR NF200

G 03 012	Adaptor for 1.5/2 ml tubes, max tube dia 11 mm
G 03 014	Adaptor for 7 ml vacuumed/ non vacuumed tubes, max tube dia 13 mm
G0 3 015	Adaptor for 5 ml vacuumed/ non vacuumed tubes, max tube dia 13 mm

## 2.3. GENERAL PRESENTATION



1	LID	5	Rotor
2	Lock pin	6	Manual LID opening hole
3	Lid Gasket	7	Control panel
4	Bowl	8	Electrical cables inlet, On / off switch and fuses

## 2.4. RECAUTIONS AND USAGE LIMITATIONS

- Do not use the device for any purpose other than the usage purpose.
- Prior to first use, the user's manual should be read and the device is only to be used by authorized and trained personnel. Only authorized technical personnel handle the product in case of any failure.
- The working bench should be durable to the device weight and vibration isolated.
- Ensure that the rotor is placed correctly prior to usage.
- According to the standard IEC 61010-2-020, anyone and any hazardous materials should not be in the 300 mm safety zone while centrifuge is running.
- Do not move the device while it is running.
- Do not open the lid while rotor is spinning.
- Apply the manual lid opening procedure in the case of power cut or in the case of any error.
- Use only the the spare parts, rotors and accessories which are supplied by NUVE.
- Load the rotor according to the explanations in the user's manual.
- Start the device after ensuring the rotor is loaded correctly.
- Do not use the centrifuge in areas which are in explosive danger.
- Do not centrifuge the explosive, flammable, radioactive, corrosive materials and the materials which may react with each other.
- The centrifuge and the rotor are not microbiologically leak-proof. Use tubes with leak-proof covers, if hazardous, toxic and pathogenic microorganisms are centrifuged.
- Do not use corrosive materials which may be harmful for the device integrity, rotor and accessories.
- Do not use rotors and accessories with corrosion and mechanical damages.
- Mains supply should be appropriate to power of the device and grounded.
- Use tubes whose sizes are suitable to the rotor and accessories.
- Tubes which are used in the centrifuge should not be deformed by the effect of the centrifuge force.

- Use glass tubes to balance, if glass tubes are used. Use plastics tubes to balance, if plastics tubes are used.
- Do not start the device unless tubes are in balance.
- Imbalance loading may cause mixing the samples, broken tubes, and damages on the rotor and motor shaft.



If mentioned warnings are not considered, nūve will not be responsible from their results.

## SECTION 3 – SYMBOLS



Symbol in the operating instructions: Attention, general hazard area. This symbol refers to safety relevant warnings and indicates possibly dangerous situations. The non-adherence to these warnings can lead to material damage and injury to personal.



Symbol in the operating instructions: This symbol refers to important circumstances.

## SECTION 4 – INSTALLATION

### 4.1. LIFTING AND TRANSPORT

Because of the heavy weight of the centrifuge, all lifting and transport must be carried out using proper handling equipment. The centrifuge should be lifted from underneath and never be turned over.

### 4.2. UNPACKING

Remove the packing cardboard box and the second nylon packing around the centrifuge. The below written are provided with the instrument, please check them;

- 1 ea. User's manual
- 1 ea. Warranty certification
- 1 ea. Power cable
- 1 ea. Manual lid opening tool

### 4.3. POSITIONING

- Check that no damage has occurred during transport.
- Check that the positioning is suitable for users.
- Lift the centrifuge (use proper handling equipment if necessary) underneath and carry it to its place. Check that the centrifuge is stable on its four pads.
- The bench-top must be rigid enough to support the weight and vibrations.
- Leave 30 cm. free space on the every side of the centrifuge.
- Open the lid by using unlocking tool and check no substances left in the bowl.
- Make sure that the centrifuge does not occupy the utilization space of nearby equipment or do damage to them.
- The user should be able to follow the centrifuge during the operation.





According to the standard IEC 61010-2-020, anyone and any hazardous materials should not be in the 300 mm safety zone while centrifuge is running.



The centrifuges are designed to operate safely under the following conditions:

- Indoor use only
- Ambient temperature: 5 °C to 25 °C.
- Maximum relative humidity of 80% for temperature up to 22 °C.
- Maximum altitude: 2000 m.
- Temperature for maximum performance: 15 °C / 25 °C.

#### 4.4. MAIN SUPPLY

The centrifuge requires 230 V, 50 / 60 Hz. Please make sure that the supplied mains match the required power ratings. If no, provide an extra line to support.



Always plug the sterilizer/ovens to properly earthed sockets.



A supply fitted with a circuit breaker should be used for protection against indirect contact in case of an insulation fault.

## SECTION 5 – OPERATING UNIT

### 5.1. OPERATING

- Open the lid and check that there is no sample in the instrument.
- Turn the centrifuges on by using On/Off switch.
- See that the display and control panel activates.
- Learn the functions of the control panel.
- Set the values and start the operation.

### 5.2. DISPLAY AND CONTROL PANEL

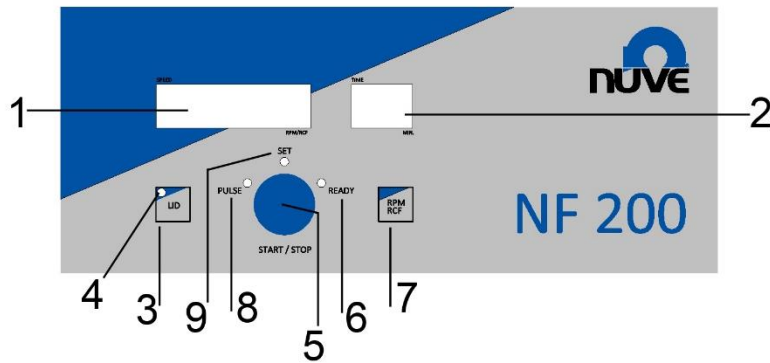

### 01- Status Display

This display shows the speed values (RPM or RCF) during programming. It also indicates accelerating condition, braking condition, power failure condition, open lid condition and the condition that occurs when Start is pressed while the lid is open by the expressions Acc, br, E OFF, oPEn, cLoSE Lid, respectively. The error codes that occur in case of any failure condition are also shown on this display.

### 02- Time Display

Display of the run time from 1 min. to 99 min. and hold position (H).

### 03- LID Key

Opens the lid if the lid indicator lights up

### 04- LID Indicator Led

It turns on if the lid remains open or is not properly closed.

### 05- ENCODER Button

This has two functional move. Turn clockwise and opposite clockwise, reach program menu, set value and "READY" situation. By turning the Encoder button increase or decrease values during programming stage. When Led is "READY" situation, by pushing Encoder button start device. Stops the run by starting the braking phase manually.

### 06- READY Led

It indicates that the device ready to run.

### 07- RPM/RCF Key

Check the RPM or RCF value during the operation.

### 08- PULSE Led





It indicates that the user is on the program menu.

### 09- Set Menu Led

It indicates that the user is on the set value menu.

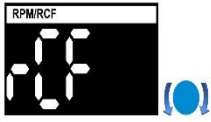
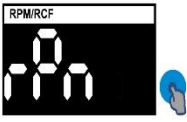
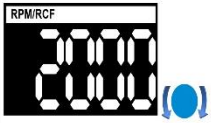
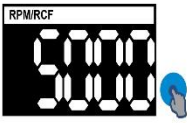
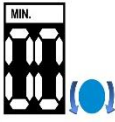
Determine the rotor type, the speed and time, the acceleration and braking rates.

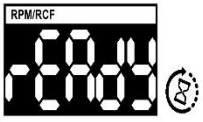
- Load the rotor with samples by paying attention to the dynamic and static balances.
- Set the all parameters for program.
- Close the lid, see that the lid open warning led turns off.
- Push the Encoder button.

<b>RPM / RCF</b>		The display flashes. By turning the Encoder button select RCF or RPM.		Push the Encoder button and save the value.
<b>SPEED SETTING</b>		The display flashes. By turning the Encoder button increase or decrease run speed.		Push the Encoder button and save the value.
<b>TIME SETTING</b>		The display flashes. By turning the Encoder button set operating time value.		Push the Encoder button and save the value.
<b>START</b>		Wait until "READY" expression appears on the display		Push the Encoder button and start the device.



The correct rotor type should be selected in order to see the correct RCF values during the run.

### 5.3.1 PULSE MODE

- Load the rotor with samples by paying attention to the dynamic and static balances.
- Set the all parameters for program.
- Close the lid, see that the lid open warning led turns off.

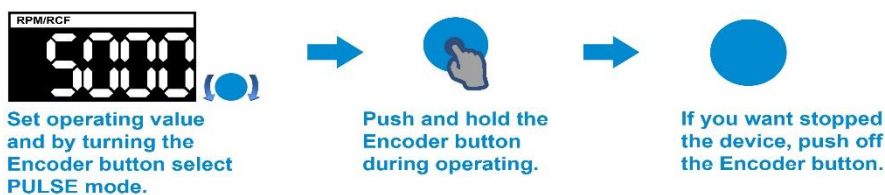

- You can reach the desired speed by pressing and holding the Encoder button (6) within the RPM speed limits you have set.
- In the PULSE mode, the rotor operates according to the set acceleration and braking values you set.
- While operating in Pulse mode, press the Encoder button (6) and start counting from the moment the rotor starts to accelerate. When you take your hand out of the Encoder button, it will stop counting by braking.



You may display the RPM or RCF value on the speed display during the run by pushing the function button.



The centrifuge waits at the stand-by position with the program values of the last program.



Please open the lid after every operation, otherwise the centrifuge cannot be run again.

#### 5.4 SAFETY INTERLOCK SYSTEM

The safety interlock system prevents opening of the lid when the rotor is spinning.

The centrifuge does not operate until the lid is closed and the lid remains locked until the rotor stops spinning. The “Lid Open” indicator turns on to warn the user if the lid is not closed properly.



If power failure occurs, access to the samples is possible by opening the lid with a special tool. Please see the manual lid opening section for further information.

#### 5.5 MANUAL LID OPENING

In case of a power cut or any defects, the instrument would be opened manually to be able to get the samples.

To open the lid manually :

- Power off the instrument
- Insert the manual lid opening tool into the hole at the front side of the instrument.
- Push the tool while keeping it vertically until the lid is opened.
- **After opening the lid manually, turn off and on device.**



Before opening the lid manually, make sure that the rotor already stopped spinning. Upon opening the lid, lift it by hand and observe the rotor. If the rotor is still spinning, close the lid and wait approximately 10 minutes before repeating the operation. This operation must be carried by someone who is informed of the danger and of the precautions which must be undertaken.



After opening the lid manually, turn off and on device.

## SECTION 6 – OPERATING PRINCIPLES

### 6.1 PREPARATION OF THE ROTOR TO RUN

Before installation, check the rotor for corrosion and cleanliness.

Chemical corrosion or mechanical corrosion may do severe damage to the rotor and the centrifuge. Particles which are stuck inside the inserts cause the breakage of tubes and lead to major imbalance please check to make sure that no particles are left on the rotor.

The central hole of the rotor and the motor shaft should also be clean and dry before all centrifugal operations and they must be kept in that way all the time.

### 6.2 LOADING

- Each tube insert must be at the same weight as the one diametrically opposite for balancing.
- In case the number of tubes which will be centrifuged is less than the capacity of the rotor, the tubes must be placed in opposite inserts. If the number of tubes that will be centrifuged is an odd number, use a water-filled tube at the same weight for balancing.



Imbalance of the rotor may cause major damage to the rotor and centrifuge.



Never attempt to introduce liquids into the tube inserts.



Balance the rotor with glass tubes if you use glass tubes for centrifugation.  
Balance the rotor with plastic tubes if you use plastic tubes for centrifugation.



Always use tubes which can withstand to the set speeds.

Examples of the proper and improper loading are shown below.

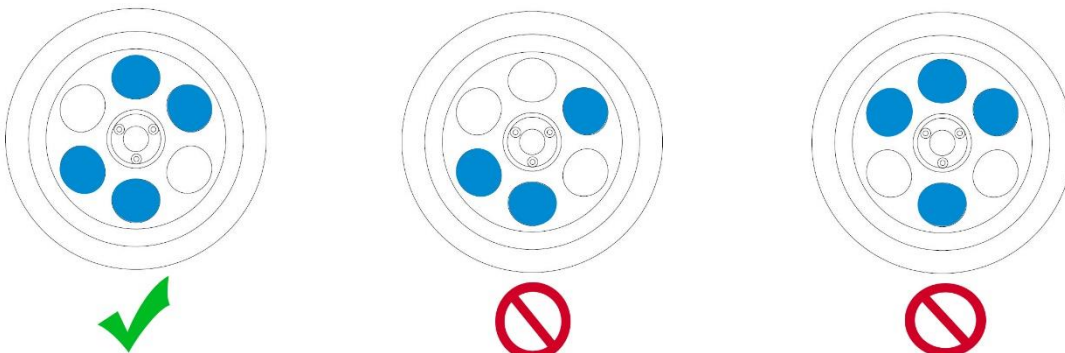

Figure 1

### 6.3 DRIVE SYSTEM

- The rotor is driven by a three phase asynchronous motor. The microprocessor control system assures the correct drive speed.
- The force applied to the rotor is directly related to the shape of the rotor, the swing-out rotor receives more load than the angle rotor does. Longer radius and more accessories increase the load of the rotor and decrease the spinning speed.
- The centrifuge does not allow the rotor to spin at a speed which it cannot resist mechanically.
- Please make that sure the correct type of rotor is selected during programming.

## SECTION 7 – CLEANING AND PERIODIC MAINTENANCE

### 7.1 PERIODIC MAINTENANCE

- Disconnect the power cable and after the maintenance check the presence of the mains grounding line.
- Rotors should be washed after every use, especially if a spillage has occurred, in warm water containing a few drops of liquid soap. (A mild washing liquid is ideal as a cleaner).
- Rotors and other accessories must be clean if any spillage or chemicals occur.
- You may use a nylon brush to clean the buckets and tube inserts of the rotor.
- **Do not use metal brushes.**
- Dry the rotor with a piece of soft absorber cloth. Please make sure that the buckets and inserts are well dried, you may use hair dryer.
- The buckets of the swing-out rotors should be greased frequently with the oil provided with the centrifuge. Please remove the light oil from the pins and put a small amount of fresh oil every time you grease. This will ensure free swinging of the buckets. Most of the imbalance problems are mostly raised by the users who do not clean and oil the pins.
- Please do not leave the rotor on a metal surface, particularly stainless steel as electrochemical reactions set off easily with the aluminum or magnesium in the rotor.
- Make sure that no deposit remains at the bottom of the bucket because the pressure of a flask or tube from above during centrifugation will certainly increase the chance of corrosion.

### 7.2 STERILIZATION

- Apply alcohol, for example %70 ethanol or isopropanol, for 10 minutes against bacteria and viruses.
- The rotors and buckets may be autoclaved at 121°C and under 215 kPa pressure for 20 minutes but please do not forget to remove all accessories.
- Do not use formaldehyde for the sterilization process.
- Phenol is a corrosive substance and should never be used.
- Glutaraldehyde is a toxic substance and increases the rate of fatty acid in the body.

### 7.3 CORROSION INFORMATION

- Nuve rotors which are made of aluminum are designed to spin at proper RCFs for many years. When used properly, their resistance to corrosion and their life span increases and the imbalance problems decrease.
- All accessories should be checked thoroughly and regularly as almost all laboratories already have the conditions which lead to corrosion easily.



If the centrifuged samples are corrosive, only rinsing with water is not sufficient. The residuals dissolve in the water and humidity on the rotor and in the buckets.



Some particles may stick to the tubes, buckets and adapters. These particles crash and do harm to anodized surface during centrifugation and ease the occurrence of corrosion.

#### 7.4 CLEANING

- Disconnect the centrifuge before cleaning.
- There is no need of daily cleaning unless a tube breakage occurs or any liquid spills.

#### 7.5 ELECTRICITY

Centrifuged at high voltages are present behind the panels. These panels are electrically disconnecting Do not open the centrifuge.

### SECTION 8 – DISPOSAL MANAGEMENT CONCEPT

The currently valid local regulations governing disposal must be observed. It is in the responsibility of the user to arrange proper disposal of the individual components.

Applicable local regulations for disposal have to be carefully observed.

The instruments and electronic accessories (without batteries, power packs etc.) must be disposed off according to the regulations for the disposal of electronic components.

Batteries, power packs and similar power source have to be dismantled from electric/electronic parts and disposed off in accordance with applicable local regulations.

### **If the centrifuge fails to operate,**

Check that,

- The on/off switch is on,
- The fuses are sound,
- The plug is not defective,
- The centrifuge is well connected to the supply,
- The electricity installation is not defective,
- Power is supplied.

In case of below written failures, related error codes are shown.

### **Error Codes**

In case of below written failures, related error codes shown on the speed display, motor starts braking.

#### **Err 3:**

- The communication between the display & main PCB and the motor driver PCB fails.

#### **Err 4:**

- Motor overheat failure. Please wait for the motor to cool down and start the centrifuge again.

#### **Err 6:**

- Motor driver PCB is defective.

#### **Lid open:**

- This failure occurs when lid is opened during the centrifugation.
- Please close the lid properly and start the centrifuge again.

#### **Eoff:**

- It occurs in case of a power failure during the run. It disappears if you wait for 2 minutes or open and close the lid again.



# SECTION 10 – ELECTRICAL CIRCUIT DIAGRAMS

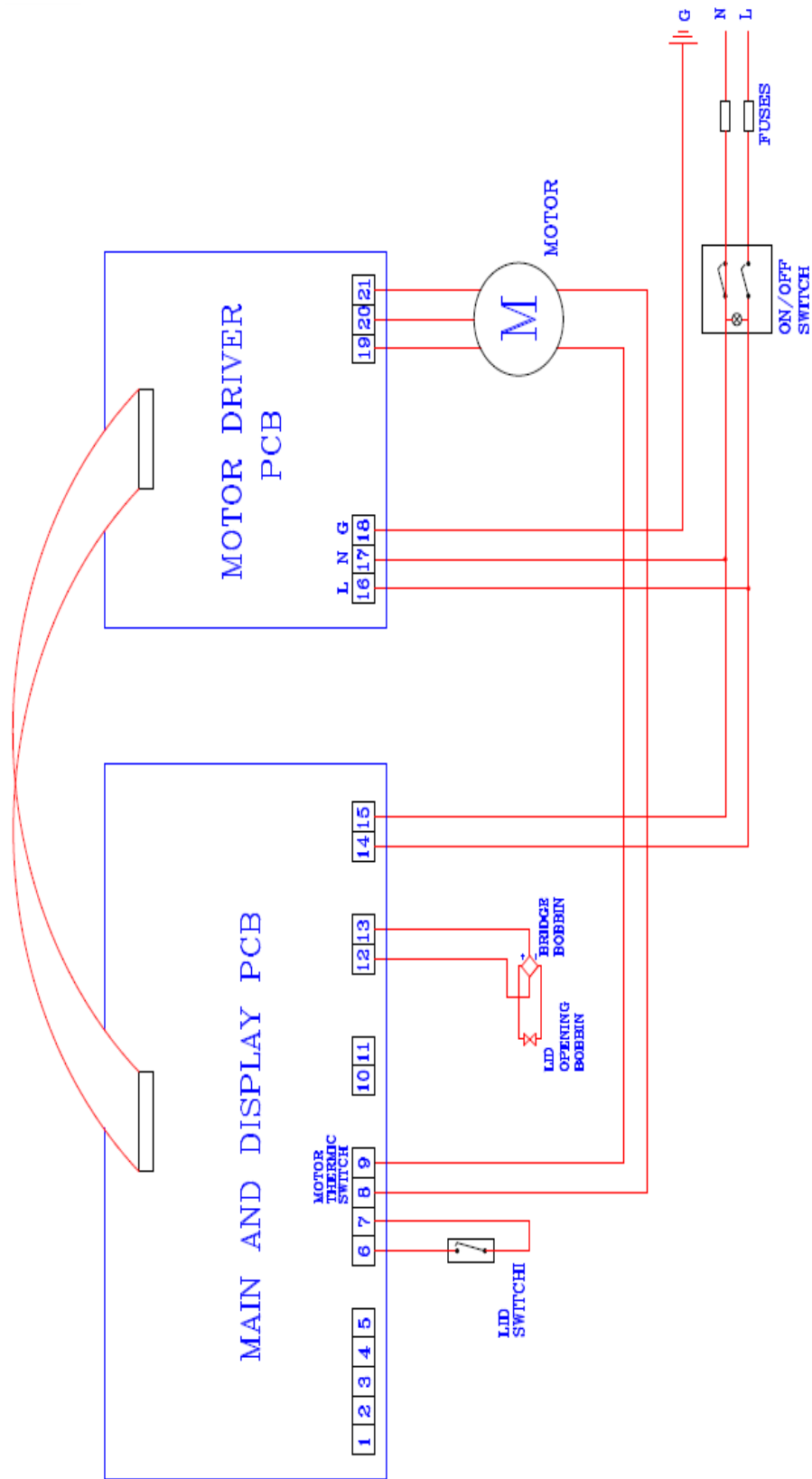

## SECTION 11 – WARNING LABEL

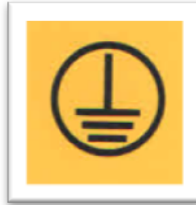

TOPRAKLI PRİZ

